



BY APPOINTMENT TO
HER MAJESTY THE QUEEN
LIFTING EQUIPMENT MANUFACTURERS AND ENGINEERS
PENNY HYDRAULICS LIMITED
CHESTERFIELD

PennyHydraulics

GOODS LIFTS

In a word

VERSATILITY

The finest range of goods lifts...
flexible, strong & cost effective.

t +44 (0) 1246 811475
e sales@pennyhydraulics.com
w pennyhydraulicsgoodslifts.com





Mezzanine floor goods lifts.

Designed & built in the UK.



Penny Hydraulics mezzanine floor lifts are manufactured in the UK allowing both standard and bespoke designs to be installed within short lead times. Our comprehensive project management helps you from site assessment through the design, manufacture and installation phases of the project, including whole life maintenance.

> WHAT WE DO

- 4 week lead times
- Manufactured in the UK
- Free site assessments
- Standard off-the-shelf designs
- Bespoke designs
- Full compliance with European legislation
- Rapid UK-wide installation
- UK-wide operator training
- 12 months parts & labour warranty
- Statutory examinations & testing
- Spare parts available on stock
- Planned maintenance programmes
- No subcontract labour
- Goods only
- Interior or exterior installations

> STANDARD SAFETY FEATURES

The following safety features are standard across the MezzLift range:

- CE marked and built in conformance with:
 - Machinery Directive 2006/42/EC
 - Lifting Operations & Lifting Equipment Regulations 1998
 - The Provision & Use of Work Equipment Regulations 1998
- Level gates fitted with electrical & mechanical interlocks
- Hazard warning safety signs
- Comprehensive O&M manual
- Emergency stop button fitted to all control stations
- Anti-slip platform surface
- Hose burst protection
- Overload protection

Clients include:



BAE SYSTEMS



Bodleian Libraries
UNIVERSITY OF OXFORD



Hampshire
County Council



TOOLBANK

VictoryWorkwear

Rolls-Royce

wetherspoon

NEW! MezzLift Heavy Duty



Open cage at mezzanine level



Pallet loading



Control buttons

The new, MezzLift Heavy Duty is a robust and versatile mezzanine floor lift for handling loads up to 1000kg between floors in warehouses, factories, retail stores and workshops.

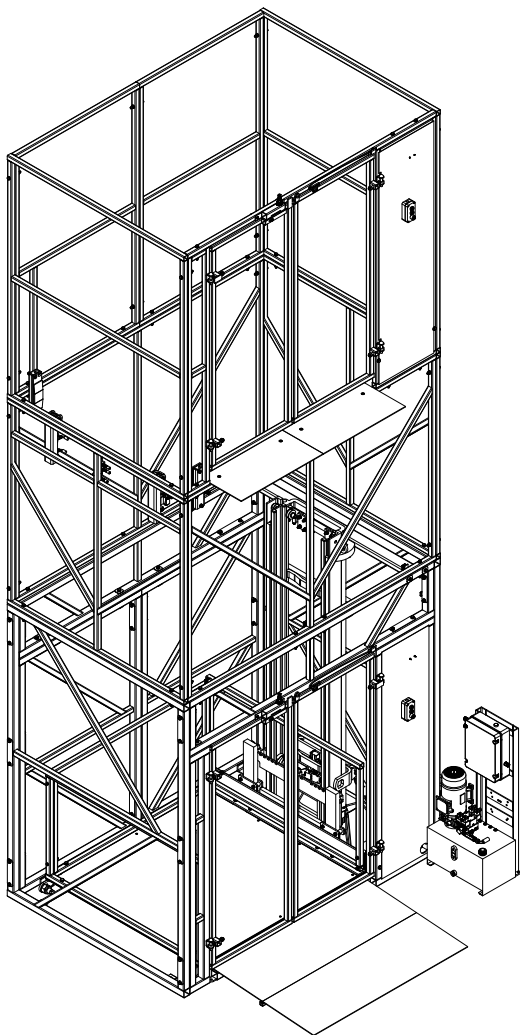

> FEATURES

- 1000kg maximum working load
- Usable platform size 1500mm x 1500mm
- 2 stop lift, up to 4000mm travel height
- Ground to mezzanine floor
- 2000mm high double gates at both levels
- Platform safety lock at upper level
- Electrically interlocked gates
- Constant pressure control buttons at both levels
- Floor mounted, no pit required
- Self-supporting mesh shaft
- Same side or through car loading

> OPTIONS

- Bespoke platform sizes
- Additional entrances
- Trolley stop barriers on platform
- Outside installation
- Choice of finish
- Clad enclosure

t +44 (0) 1246 811475

w pennyhydraulicsgoodslifts.com

Technical specifications

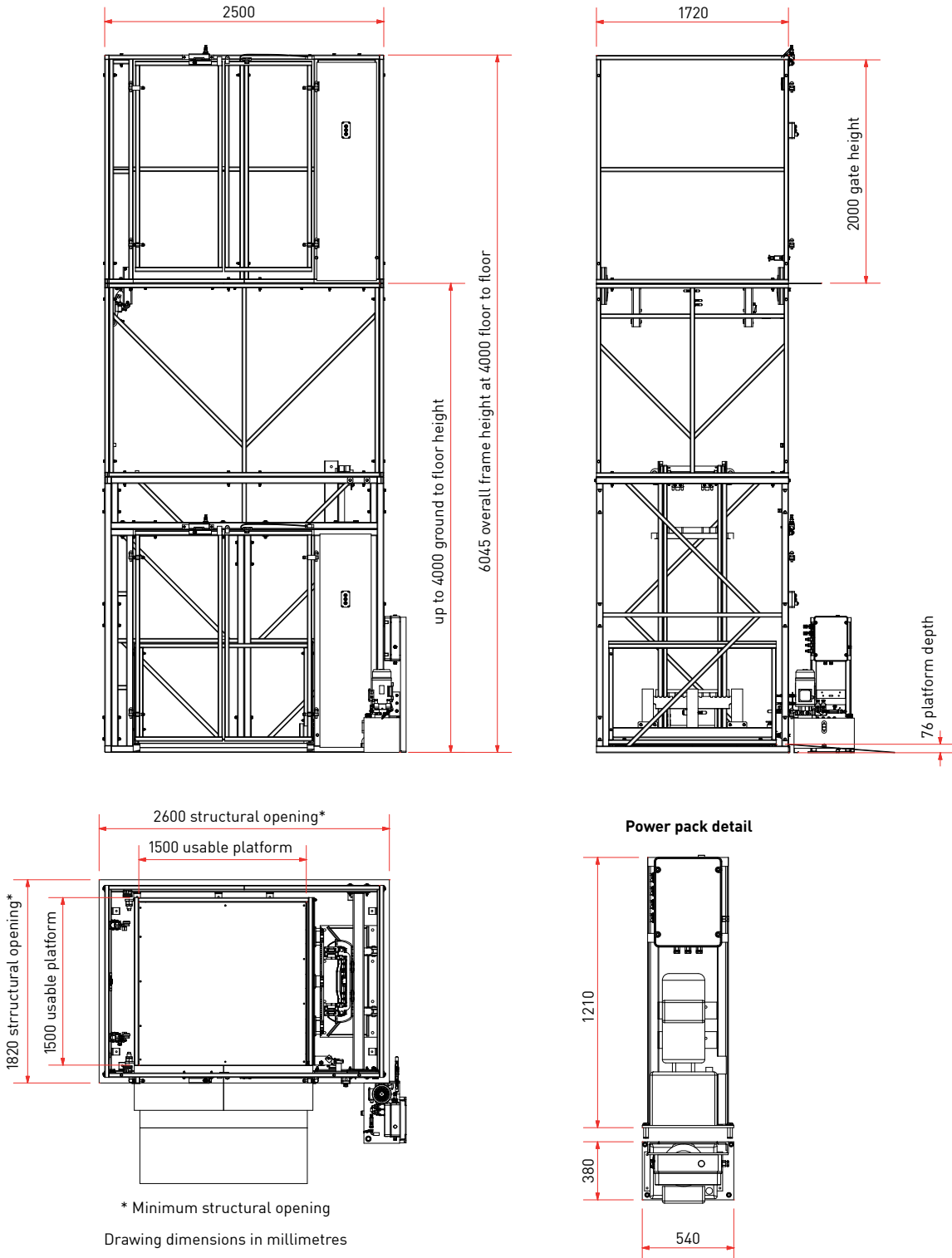

Construction

All steel construction with mesh clad shaft in black spray finish.

Power Supply

415v, 2.2kW, three phase and neutral terminated in an isolator at the lower level.

Duty Cycle

10 cycles per hour.

t +44 (0) 1246 811475
w pennyhydraulicsgoodslifts.com

MezzPro



Through car loading



Interlocked gate at upper level



Control box & power pack stand

The MezzPro is a goods lift which enables users to move goods such as trolleys or pallets safely and efficiently to a second floor within buildings, for example mezzanine floors.

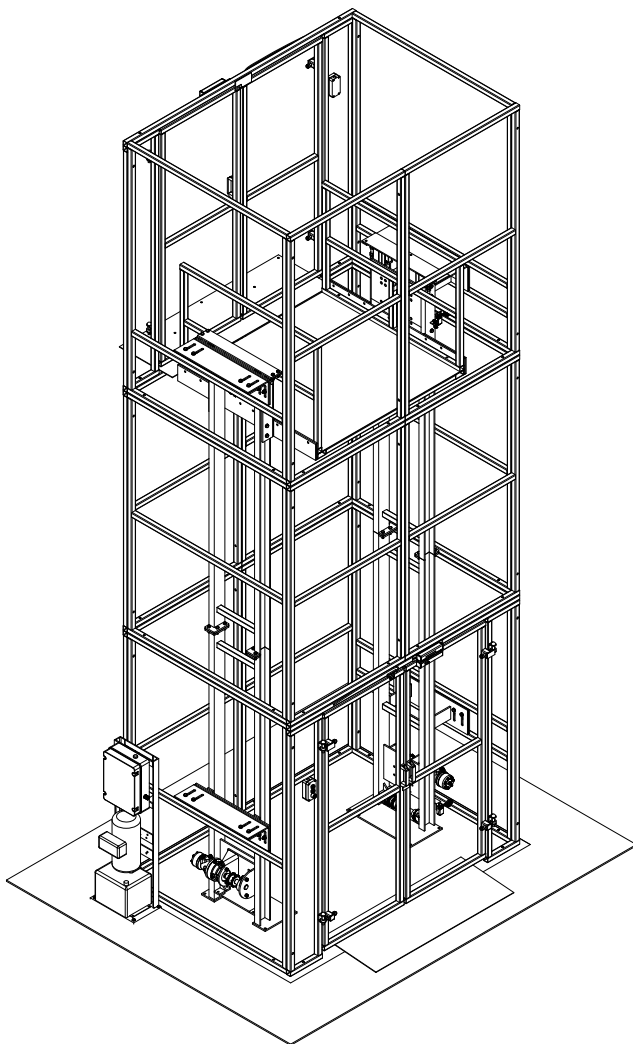

> FEATURES

- 500kg maximum working load
- Opposed mast support for minimal platform deflection
- Lift speed approx. 0.15m/s
- Fixed platform A - 1300mm x 1300mm or fixed platform B - 2000mm x 1000mm
- 2 stop lift, up to 4000mm travel height
- Ground to mezzanine floor
- 2000mm high double gates at both levels
- Electrically interlocked gates
- Constant pressure control buttons at both levels
- Floor mounted, no pit required
- Self-supporting mesh shaft
- Same side or through car loading

> OPTIONS

- Bespoke platform sizes
- Increased gate height
- Outside installation
- 90° loading or additional entrances
- Trolley stop barriers on platform
- Clad enclosure
- Choice of finish

t +44 (0) 1246 811475

w pennyhydraulicsgoodslifts.com

Technical specifications

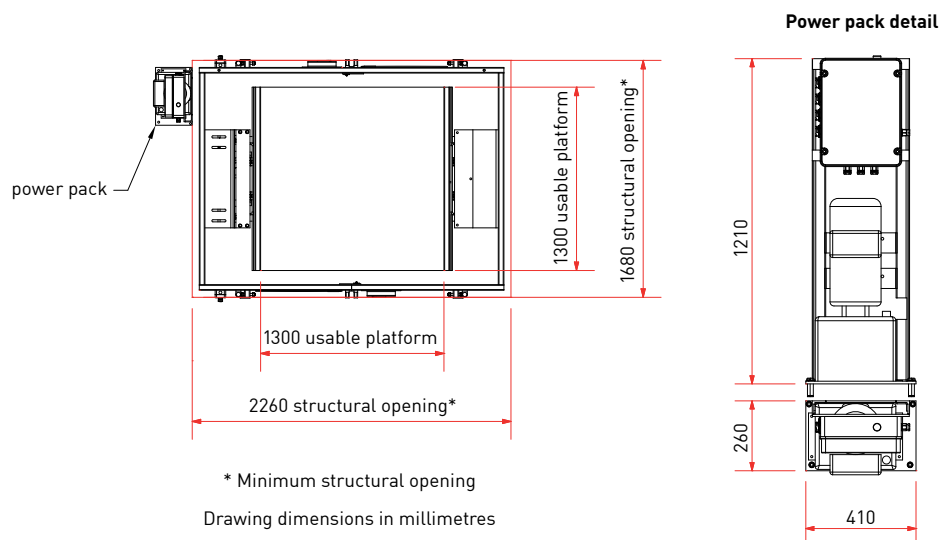
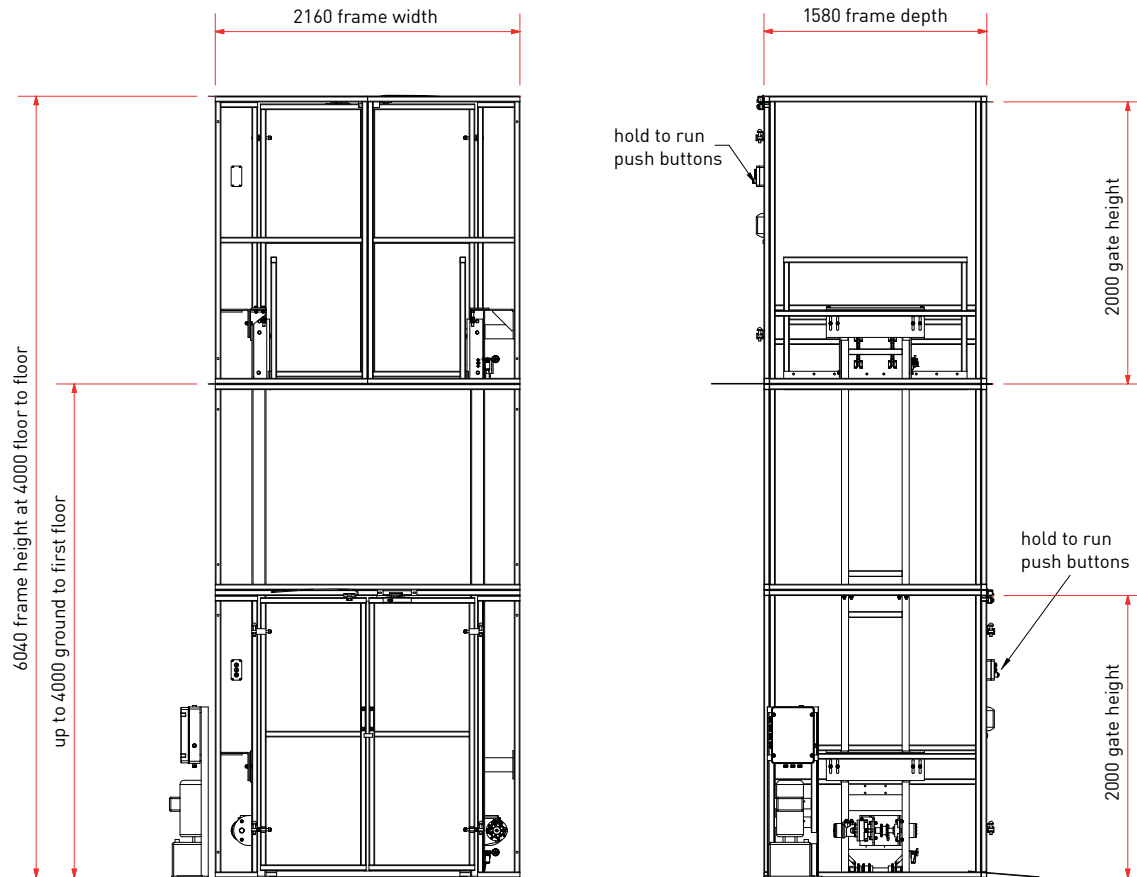

Construction

All steel construction with mesh clad shaft in black spray finish.

Power Supply

415v, 2.2kW, three phase and neutral terminated in an isolator at the lower level.

Duty Cycle

10 cycles per hour.

t +44 (0) 1246 811475
w pennyhydraulicsgoodslifts.com

MezzLight



Self-supporting mesh shaft



Pallet loading ramp

The MezzLight is a simple, robust and versatile mezzanine floor lift for handling loads up to 250kg between floors in warehouses, factories, retail stores and workshops.

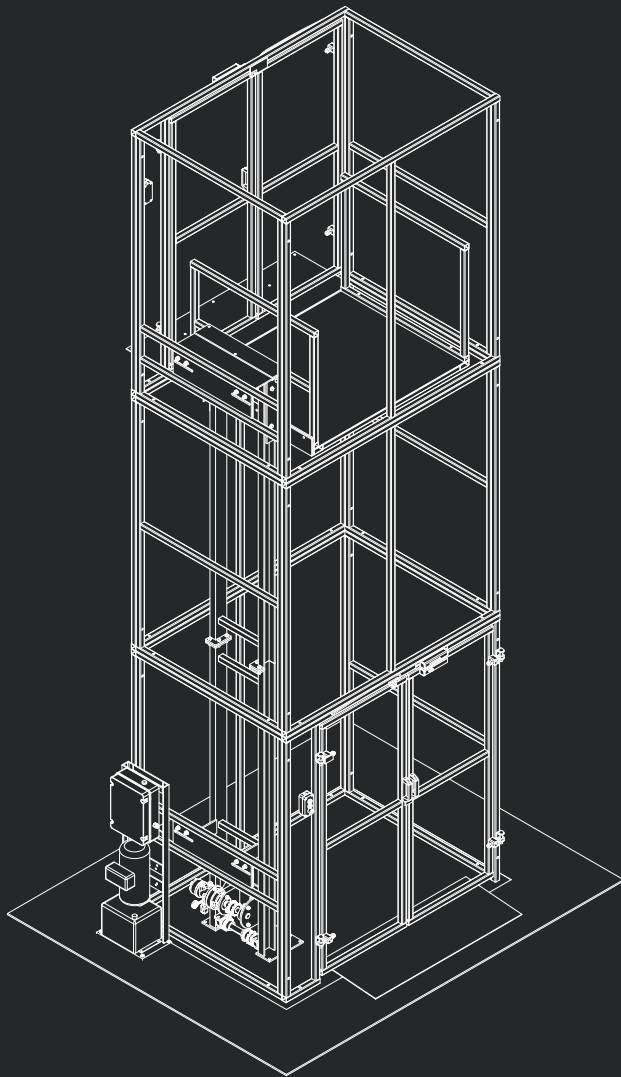

> FEATURES

- 250kg maximum working load
- Lift speed approx. 0.15m/s
- Usable platform size 1300mm x 1100mm
- Will lift Euro & UK pallets
- 2 stop lift, up to 4000mm travel height
- 2000mm high double gates at both levels
- Electrically interlocked gates
- Constant pressure control buttons at both levels
- Floor mounted, no pit required
- Self-supporting mesh shaft
- Same side or through car loading

> OPTIONS

- Bespoke platform sizes
- Increased gate height
- Outside installation
- Choice of finish
- 90° loading or additional entrances
- Trolley stop barriers on platform
- Clad enclosure

t +44 (0) 1246 811475

w pennyhydraulicsgoodslifts.com

Technical specifications

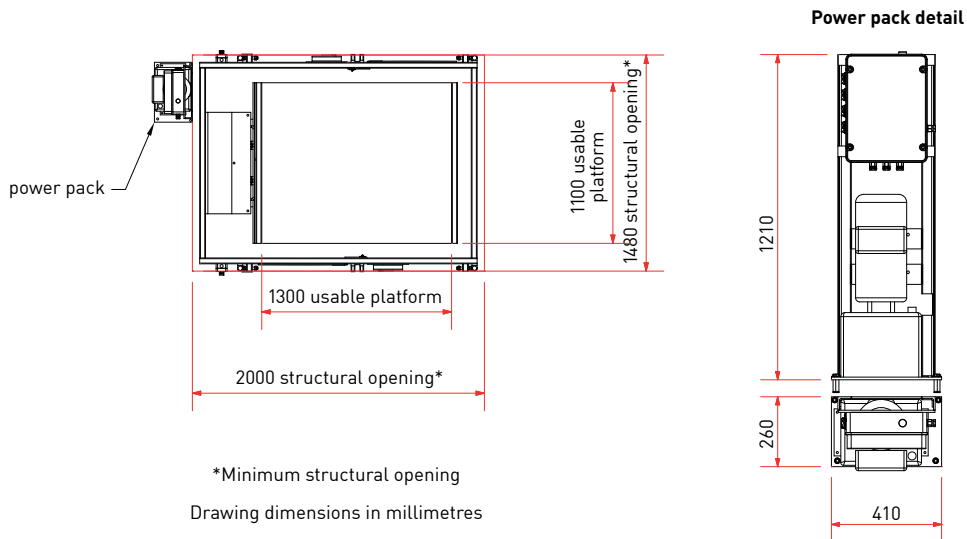
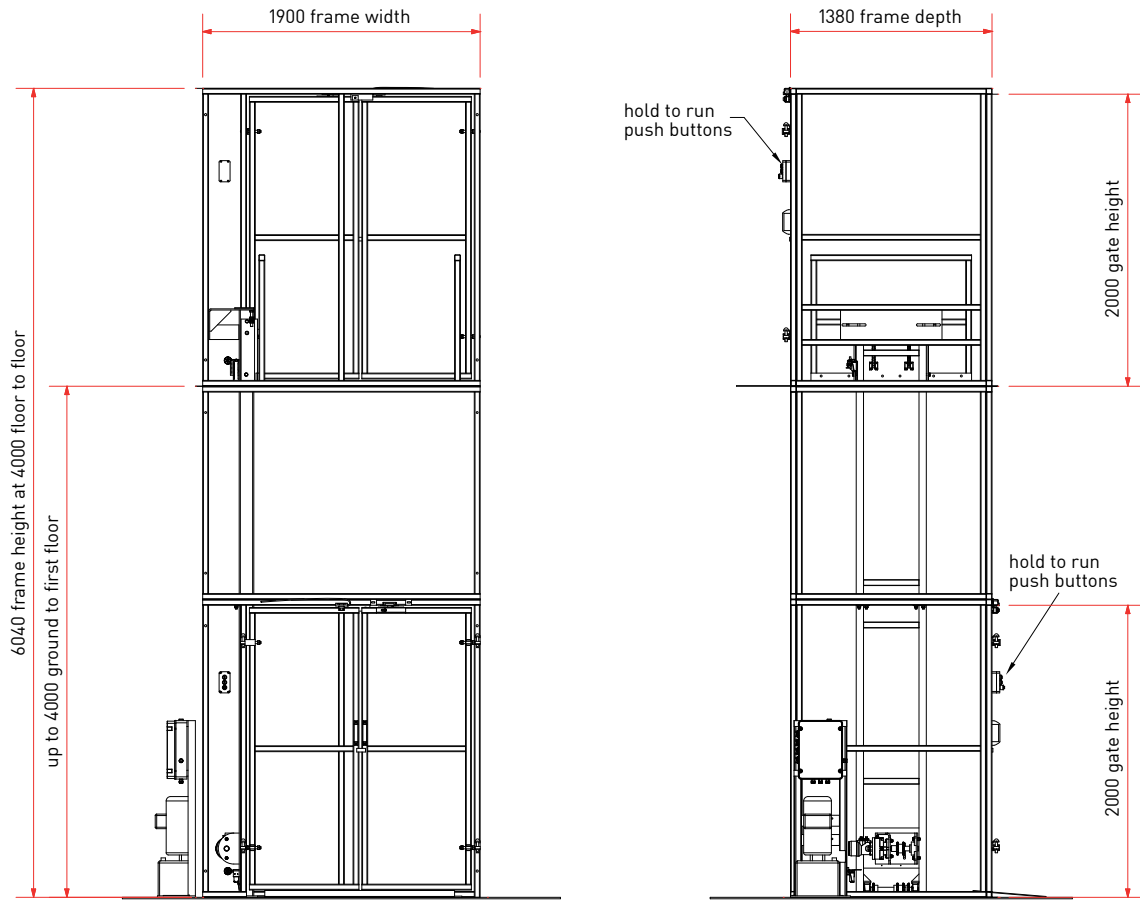

Construction

All steel construction with mesh clad shaft in black spray finish.

Power Supply

240V, 2.2kW, single phase
terminated in an isolator at the lower level.

Duty Cycle

10 cycles per hour.

t +44 (0) 1246 811475
w pennyhydraulicsgoodslifts.com

MezzLight Handloaded



Waist level access



Docks 800mm above floor height



Ground to mezzanine

The MezzLight Handloaded is designed to easily load and unload goods such as crates and boxes at waist height.

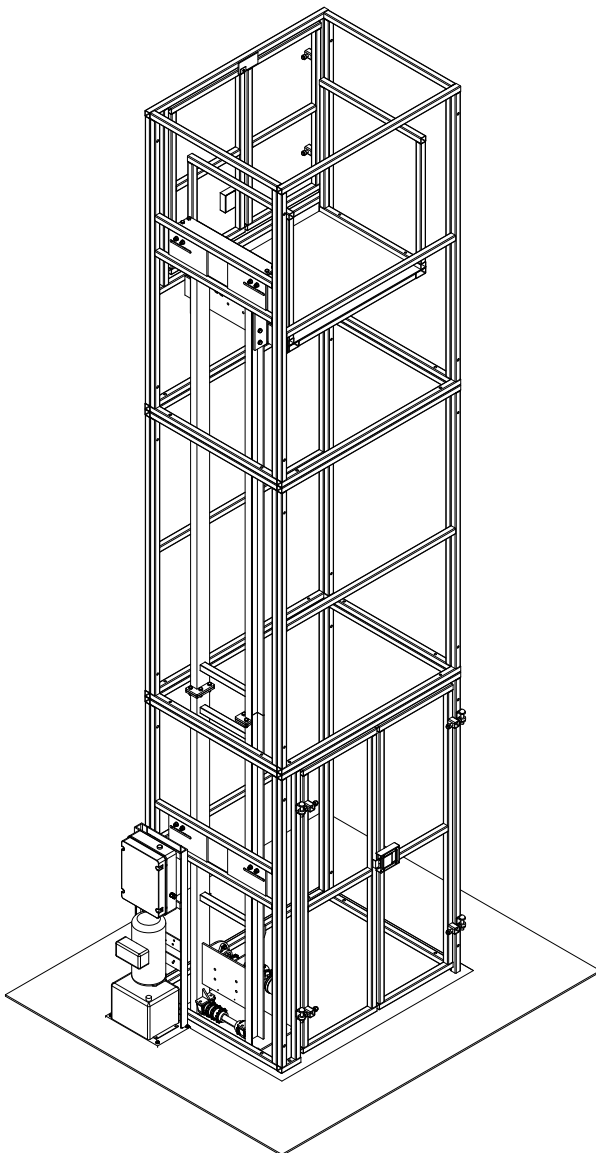

> FEATURES

- 250kg maximum working load
- Lift speed approx. 0.15m/s
- Usable platform size 1000mm x 800mm
- 2 stop lift, up to 4000mm travel height
- Ground to mezzanine
- Docks 800mm above floor height
- Slam shut gates
- Hold to run handle at lower level
- Same side or through car loading

> OPTIONS

- Bespoke platform sizes
- Increased gate height
- Outside installation
- Choice of finish
- 90° loading or additional entrances

t +44 (0) 1246 811475
w pennyhydraulicsgoodslifts.com

Technical specifications

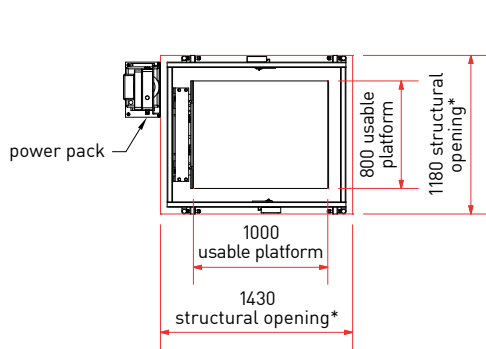
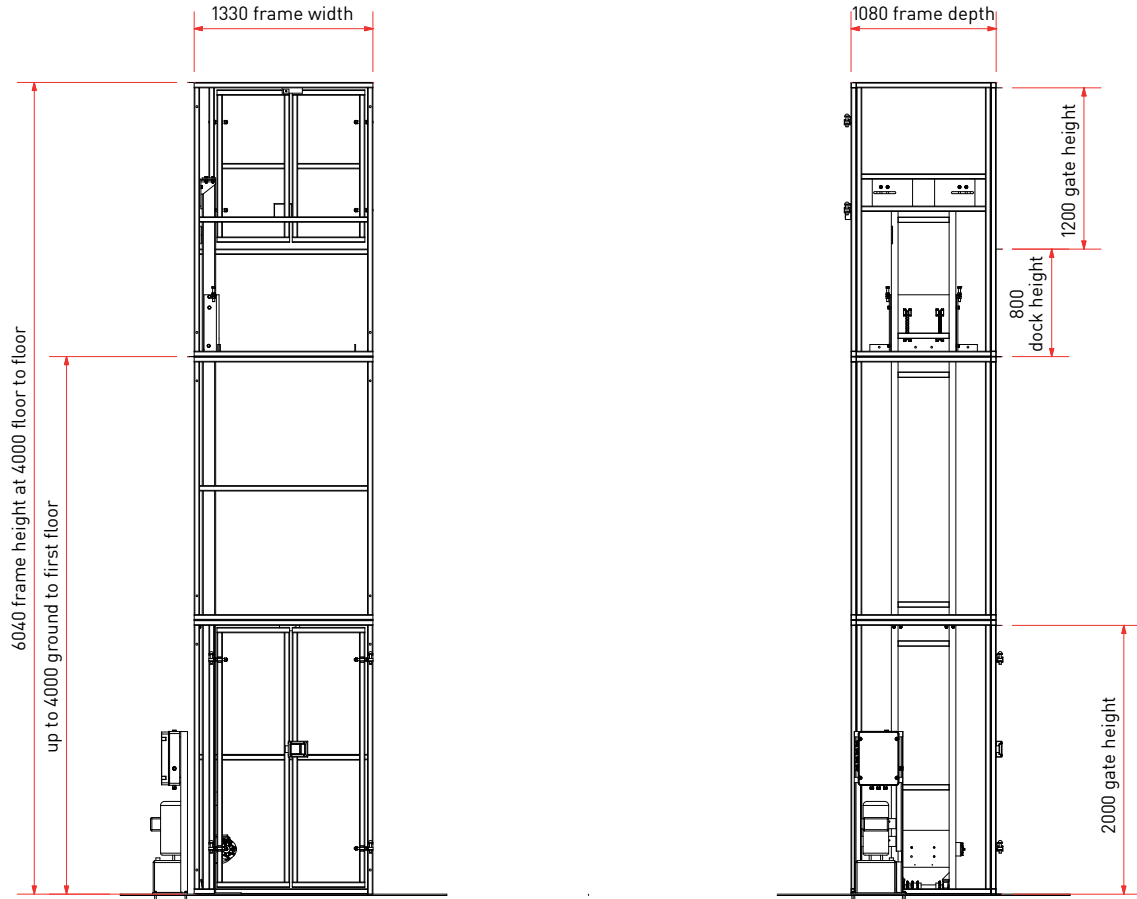

Power pack detail

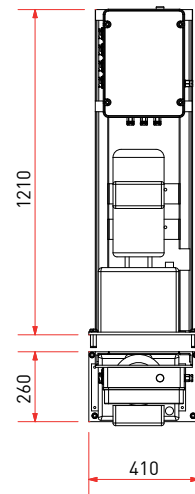

*Minimum structural opening
Drawing dimensions in millimetres

Construction

All steel construction with mesh clad shaft in black spray finish.

Power Supply

240V, 2.2kW, single phase
terminated in an isolator at the lower level.

Duty Cycle

10 cycles per hour.

t +44 (0) 1246 811475
w pennyhydraulicsgoodslifts.com

3 Tier MezzPro

Taking it to the next level



The 3 Tier MezzPro goods lifts enable users to move goods such as trolleys or pallets safely and efficiently to first and second floor storage areas.

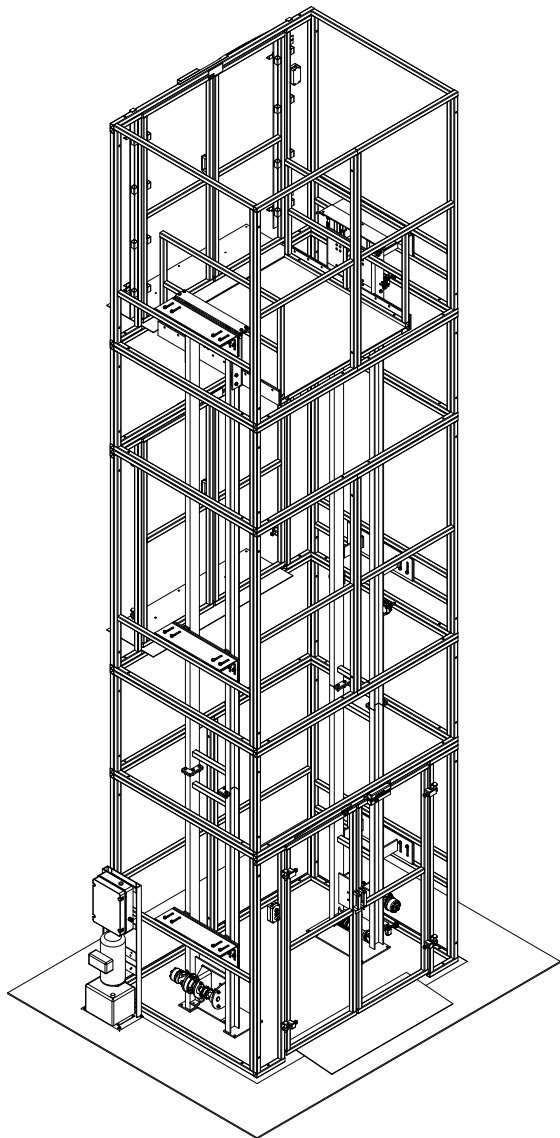

> FEATURES

- 500kg maximum working load
- Opposed mast support for minimal platform deflection
- Lift speed approx. 0.15m/s
- Fixed platform A - 1300mm x 1300mm or fixed platform B - 2000mm x 1000mm
- 3 stop lift up to 6500mm travel height
- Ground plus 2 additional stops
- 2000mm high double gates at all levels
- Electrically interlocked gates
- Constant pressure control buttons at all levels
- Floor mounted, no pit required
- Self-supporting mesh shaft
- Same side or through car loading

> OPTIONS

- Bespoke platform sizes
- Increased gate height
- Outside installation
- 90° loading or additional entrances
- Trolley stop barriers on platform
- Clad enclosure
- Choice of finish

t +44 (0) 1246 811475
w pennyhydraulicsgoodslifts.com

Technical specifications

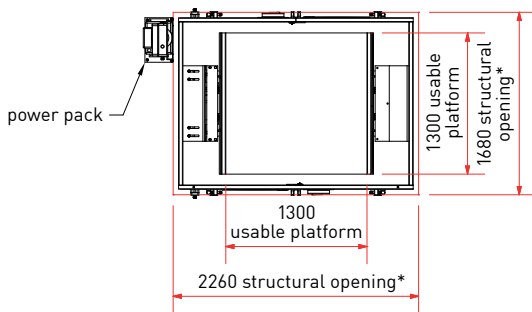
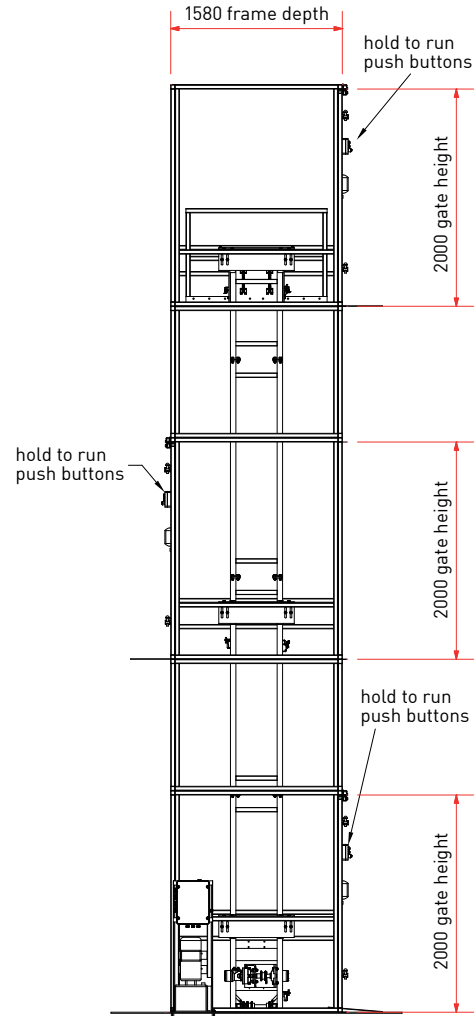
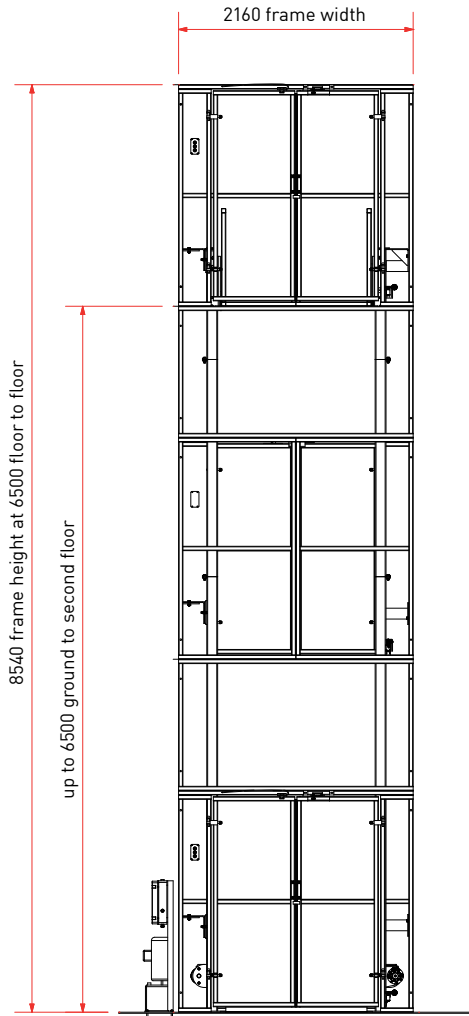

*Minimum structural opening
Drawing dimensions in millimetres

Power pack detail

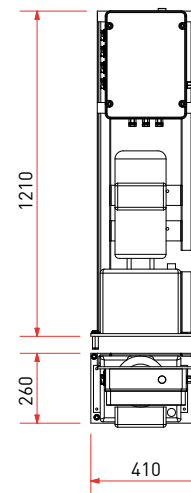

Construction

All steel construction with mesh clad shaft in black spray finish.

Power Supply

415v, 2.2kW, three phase and neutral terminated in an isolator at the lower level.

Duty Cycle

10 cycles per hour.

t +44 (0) 1246 811475
w pennyhydraulicsgoodslifts.com

3 Tier MezzLight

Aim high, lower your costs



The 3 Tier MezzLight is a simple, robust and versatile mezzanine floor lift for handling loads up to 250kg between three floors in warehouses, factories, retail stores and workshops

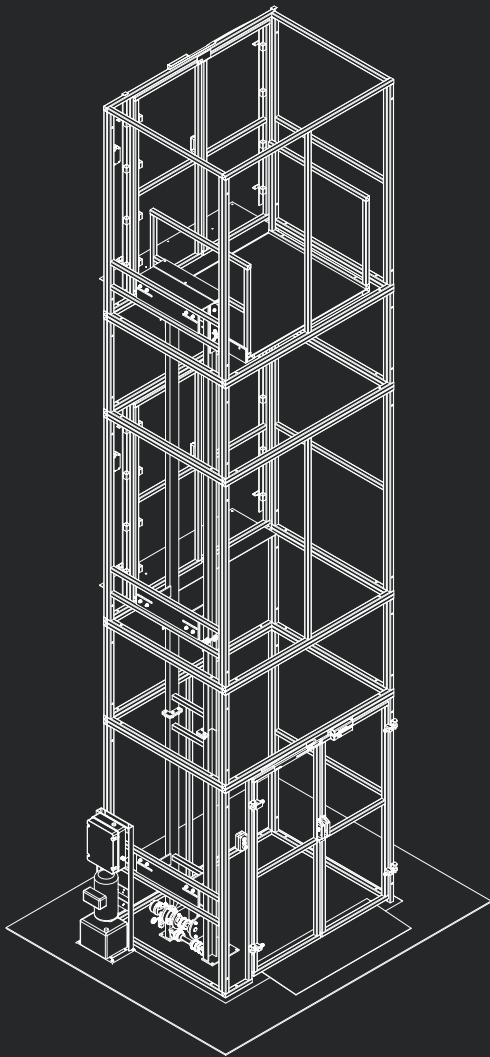

> FEATURES

- 250kg maximum working load
- Lift speed approx. 0.15m/s
- Usable platform size 1300mm x 1100mm
- Will lift Euro & UK pallets
- 3 stop lift up to 6500mm travel height
- 2000mm high double gates at all levels
- Electrically interlocked gates
- Constant pressure control buttons at all levels
- Floor mounted, no pit required
- Self-supporting mesh shaft
- Same side or through car loading

> OPTIONS

- Bespoke platform sizes
- Increased gate height
- Outside installation
- Choice of finish
- 90° loading or additional entrances
- Trolley stop barriers on platform
- Clad enclosure

t +44 (0) 1246 811475

w pennyhydraulicsgoodslifts.com

Technical specifications

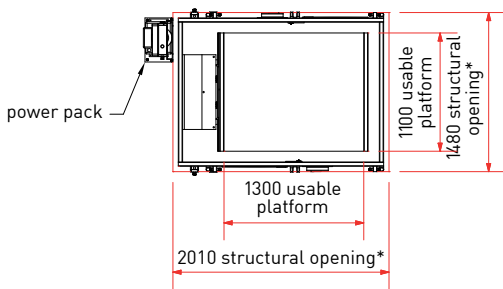
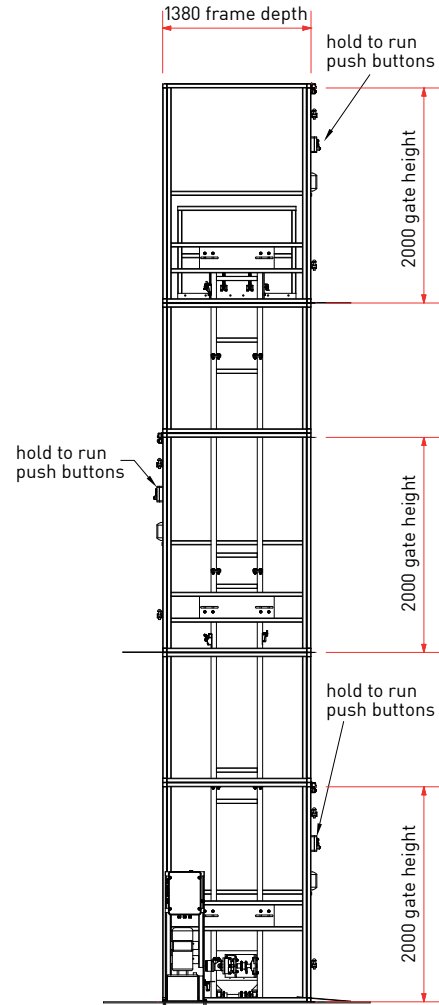
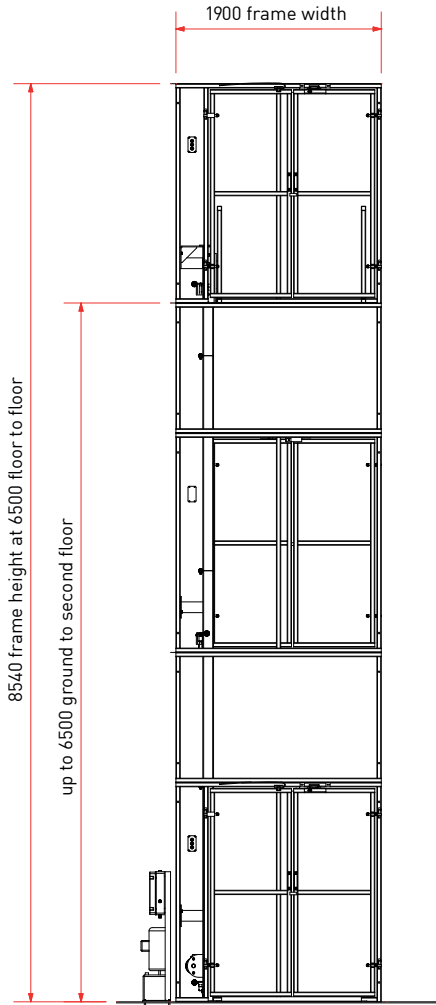

*Minimum structural opening
Drawing dimensions in millimetres

Power pack detail

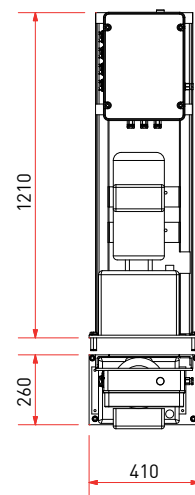

Construction

All steel construction with mesh clad shaft in black spray finish.

Power Supply

415v, 2.2kW, three phase and neutral terminated in an isolator at the lower level.

Duty Cycle

10 cycles per hour.

t +44 (0) 1246 811475
w pennyhydraulicsgoodslifts.com

BayLift



Loading Bay design



Vertical BayLift with platform lowered

The BayLift is ideal for lifting loads between different levels where the height difference is less than 1500mm, such as loading bays and docks.

With no need for a lift pit the BayLift offers a practical load handling solution where alternative equipment such as conventional scissor lifts or dock levellers cannot be installed.

Separate versions are available with capacities from 500kg to 1000kg along with a range of platform sizes that ensure the BayLift can safely handle crates, pallets, roll cages, sack barrows and many other loads.

> FEATURES

- 500kg or 1000kg maximum working load
- Platform size up to 2400mm x 1500mm
- Folding barrier on platform
- 2 stop lift, up to 1500mm travel height
- Constant pressure control
- Floor mounted, no pit required
- Folds away after use

> OPTIONS

- Bespoke platform sizes
- Trolley stop or anti-roll-off toe on platform
- Outside installation
- Free standing mounting bracket

BayLift Fully Guarded



Fully Guarded design



Loading bay level

A cost effective BayLift suitable for exterior sites and for loading applications where the change in level is less than 2500mm. Fully guarded for extra safety and security.

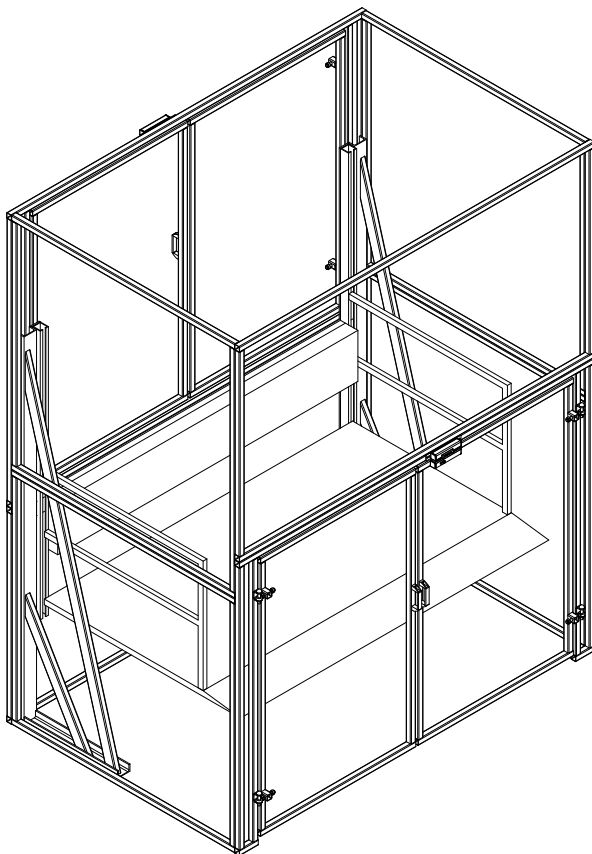

> FEATURES

- 500kg or 1000kg maximum working load
- Platform size up to 2500mm x 1500mm
- Up to 2500mm travel height
- 2000mm high gates at both levels
- Electrically interlocked gates
- Constant pressure control
- Floor mounted, no pit required
- Self-supporting mesh shaft

> OPTIONS

- Bespoke platform sizes
- 90° loading or additional entrances
- Trolley stop or anti-roll-off toe on platform
- Outside installation
- Choice of finish
- Clad enclosure
- Additional height gates

CellarLift Range



Vertical CellarLift



Sloping CellarLift

Proven designs for pub and restaurant deliveries

The Problem

Traditional methods for deliveries are back breaking, time consuming and hazardous. The safe systems of work are easily overcome in an effort to speed up the operation often resulting in damage to the building, broken containers and even injury.

The Answer

CellarLifts provide a robust, reliable and cost effective solution to the problems associated with deliveries. Over 25 years of experience has gone into the current CellarLift design which is in use with every major pub and restaurant owner in the UK.

Built in Britain and built to last

We recognise that your CellarLift will be a key part of your operation and so Penny Hydraulics provides an in-house survey, design, manufacture, installation and ongoing service package to ensure consistent high standards throughout your enquiry and ownership experience.

Clients include:



t +44 (0) 1246 811475
w pennyhydraulicsgoodslifts.com

Vertical CellarLift



Vertical CellarLift with 36 gallon barrel



Also ideal for double-stacked cases

This is the market leading lift delivering outstanding performance.

The Vertical CellarLift can carry up to a 54 gallon barrel or a double stack of cases in the most arduous environments including external installations. It also occupies minimum floor space.

Many variants are possible for delivering to first floor cellars or for carrying other goods such as 2-wheeled waste bins.

> FEATURES

- Suitable for all barrel sizes
- Carries a double stack of cases
- Hold-to-run control
- No pit required
- Can operate outside
- CE marked
- Proven design

> OPTIONS

- Upgrade to carry wheelie bins
- Bespoke platform sizes
- Load through 90°
- Extended height to 3800mm
- Ongoing planned maintenance contract
- Many variants to cover most site situations

Clients include:



t +44 (0) 1246 811475
w pennyhydraulicsgoodslifts.com

Sloping CellarLift



Sloping CellarLift with 22 gallon keg



Can also be used to lift gas cylinders

The Sloping CellarLift is a unique device for delivering pub and restaurant goods where there is an existing ramp or skid in place. Each one is exclusively designed and built, following a site survey, to suit the angle of the ramp in the building to minimise building works for the customer.

> FEATURES

- Suitable for all barrel sizes
- Can operate at any angle
- Carries a double stack of cases
- Hold-to-run control
- No pit required
- CE marked
- Proven design

> OPTIONS

- Upgrade to carry wheelie bins
- Bespoke platform sizes
- Extended height to 8000mm
- Ongoing planned maintenance contract
- Many variants to cover most site situations
- Upgrade for outside use



Mini CaseHoist



Double Stack CaseHoist

Depending on the volume of goods and space available we have several designs of CaseHoist that will improve your safety and efficiency. The smallest is the Mini CaseHoist designed for a single stack of cases that takes up only 600mm x 500mm of floor space and is ideal to operate under a bar counter. The largest is the double Stack Case Hoist for high volumes or large loads.

> FEATURES

- Standard range from 80kg to 250kg maximum working loads
- Hold-to-run control
- No pit required
- CE marked
- Proven design

> OPTIONS

- Upgrade to carry wheelie bins
- Bespoke platform sizes
- Extended height to 8000mm
- Ongoing planned maintenance contract
- Many variants to cover most site situations
- Upgrade for outside use

Planned Maintenance



Our nationwide network of highly trained, specialist lifting equipment engineers delivers excellent maintenance, repair and refurbishment services to keep your goods and business moving.

Planned maintenance programmes including scheduled annual Statutory Testing give business owners peace of mind that they are complying with current UK legislation.

Our emergency breakdown service ensures your equipment is up and running in no time. Engineers carry a full stock of replacement parts so that in almost all cases they can fix any issues on their first visit.

Penny Hydraulics have many special national planned maintenance programmes in place for large national restaurant chains, retail outlets, vehicle manufacturers, pub companies, hotels and breweries covering multiple sites across the UK.

A 12-month warranty is provided as standard with all mezzanine floor and cellar lifts.

> PLANNED MAINTENANCE

Our key services include:

- Statutory Examinations & Testing in accordance with LOLER
- Maintenance in accordance with manufacturers' guidelines
- Inspection
- Service
- Issuing of Test Certificates
- Quality Reports & Surveys
- No sub-contract labour

t +44 (0) 1246 811475
w pennyhydraulicsgoodslifts.com

We've got you covered

PennyHydraulics
GOODS LIFTS

Our engineers cover
England, Scotland
and Wales.

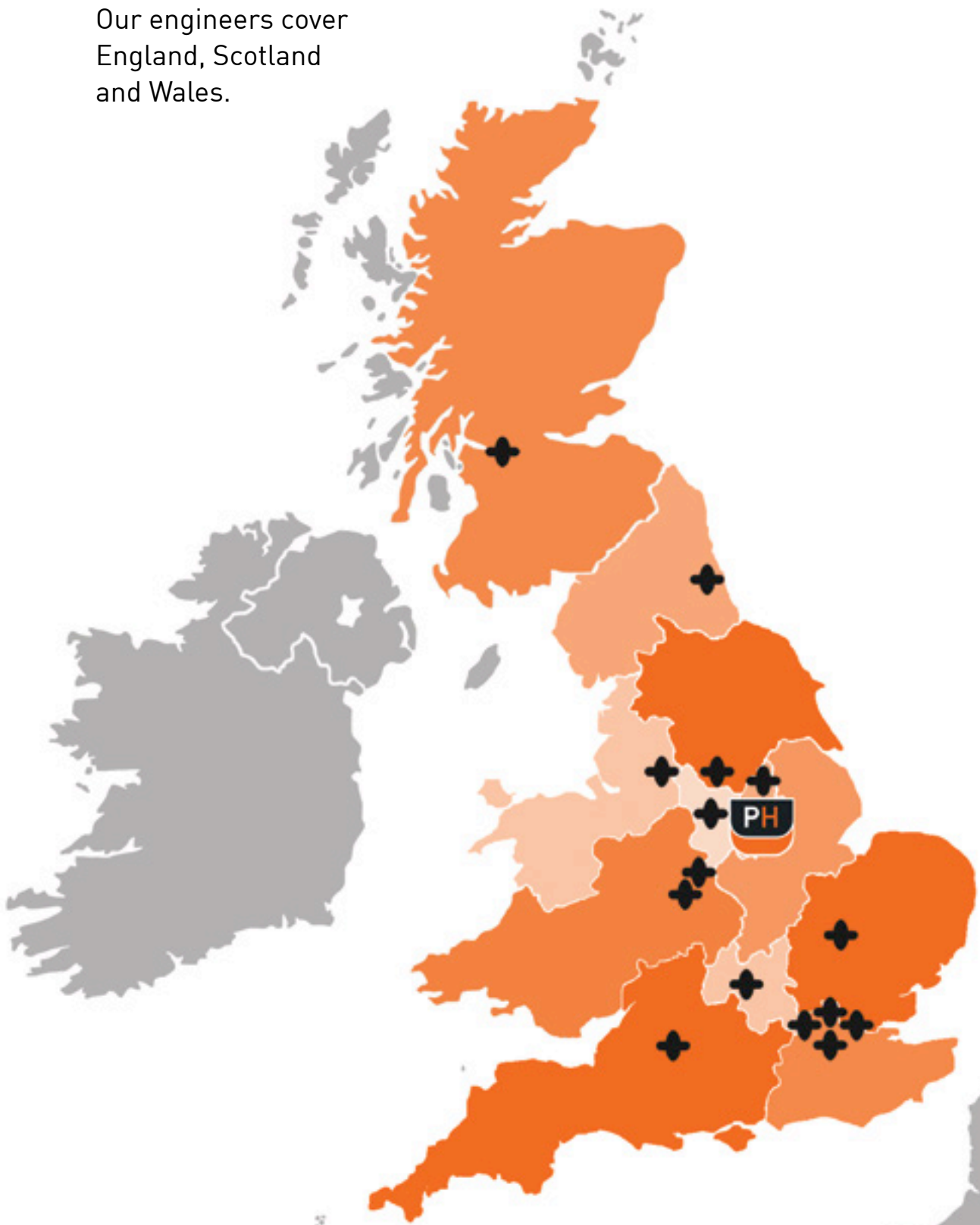

Did you know?

Penny Hydraulics is also the leading authority in the design, manufacture, installation and service of specialist lighting maintenance and winching systems, vehicle mounted lifting equipment, mechanical handling equipment for the nuclear industry and tyre handling equipment.

Visit **pennyhydraulics.com** to find out more.



Accreditations:



FM 20203

International
Registered
Design No.
DM/086426

Penny Hydraulics Limited
Station Road | Clowne | Chesterfield
Derbyshire | S43 4AB | UK
t +44 (0) 1246 811475 | f +44 (0) 1246 810403
e sales@pennyhydraulics.com
w pennyhydraulicsgoodslifts.com

